

Date rev. Description

V 1.0

House	Freshford	Sheet	1
Drawing	3D	Scale	
Material	70x135	Date	09.07.2019
Drawer	K.K.	File	Freshford 3D.dwg

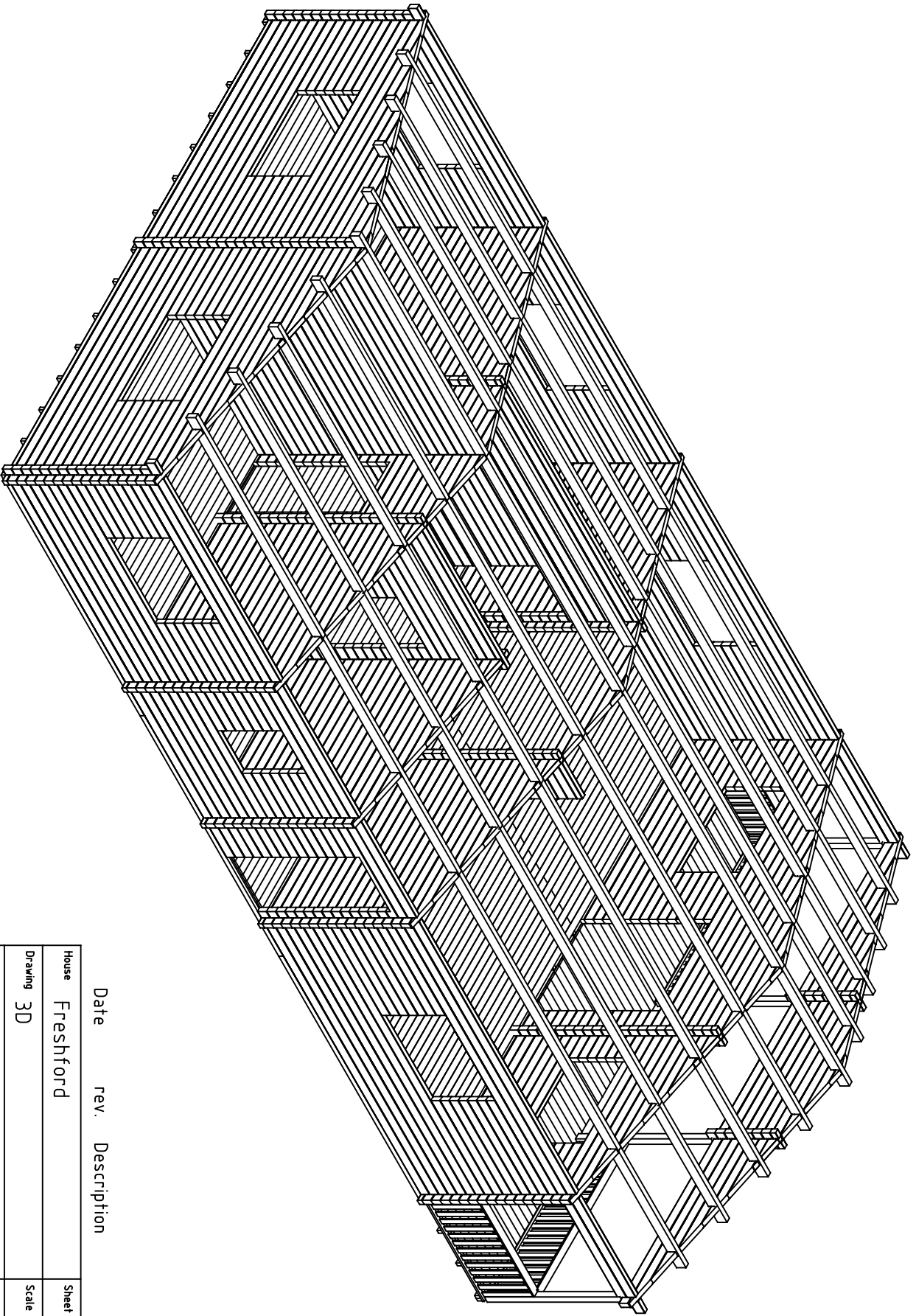

Date rev. Description V 1.0

House Freshford Sheet 1a

Drawing 3D Scale

Material 70x135 Date 09.07.2019

Drawer K.K. File Freshford 3D.dwg

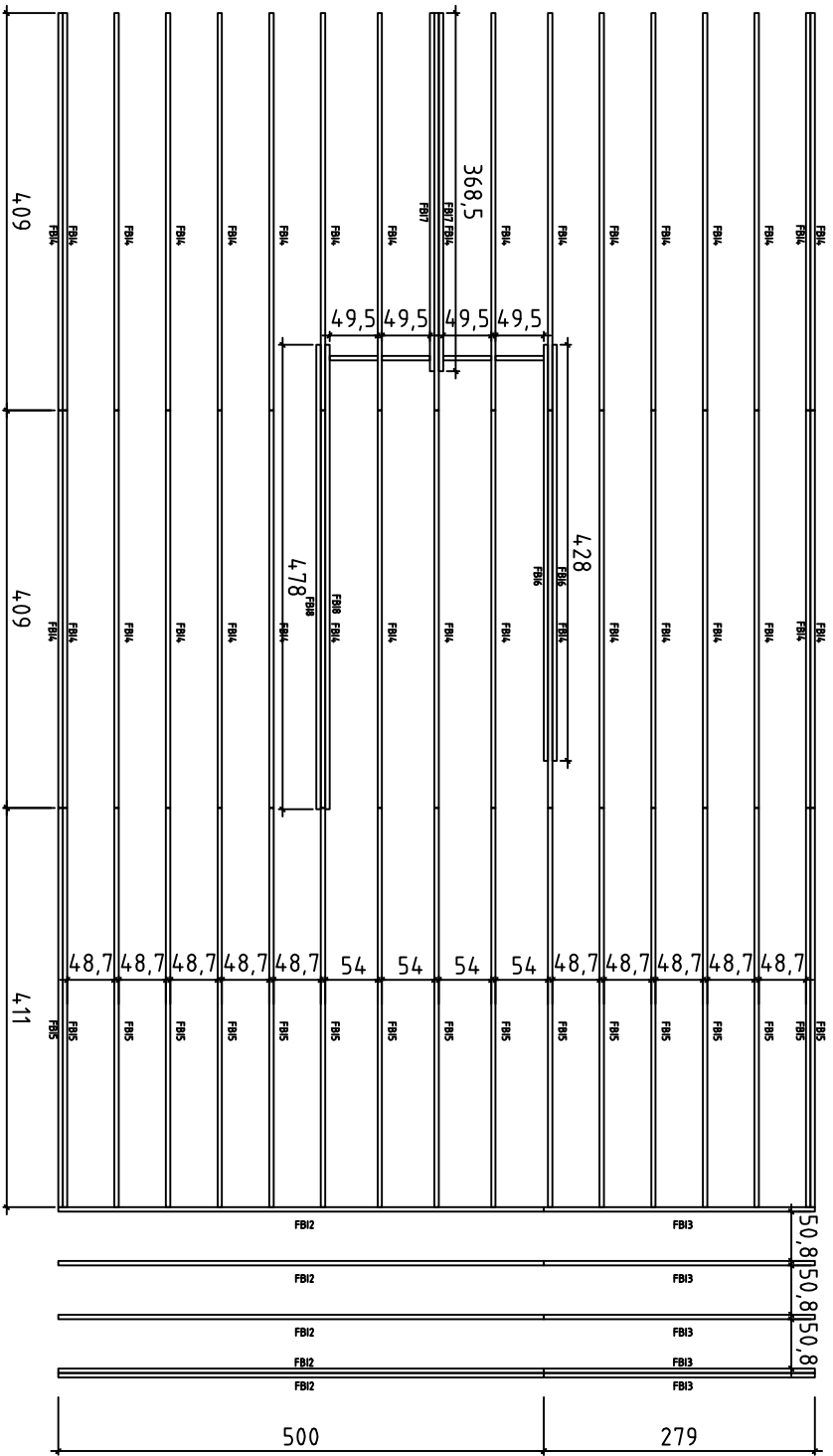

House	Freshford	Sheet	2
Drawing		Scale	1:75
Material	4,5x70	Date	07.12.2018
Drawer	K.K.	File	Freshford.dwg

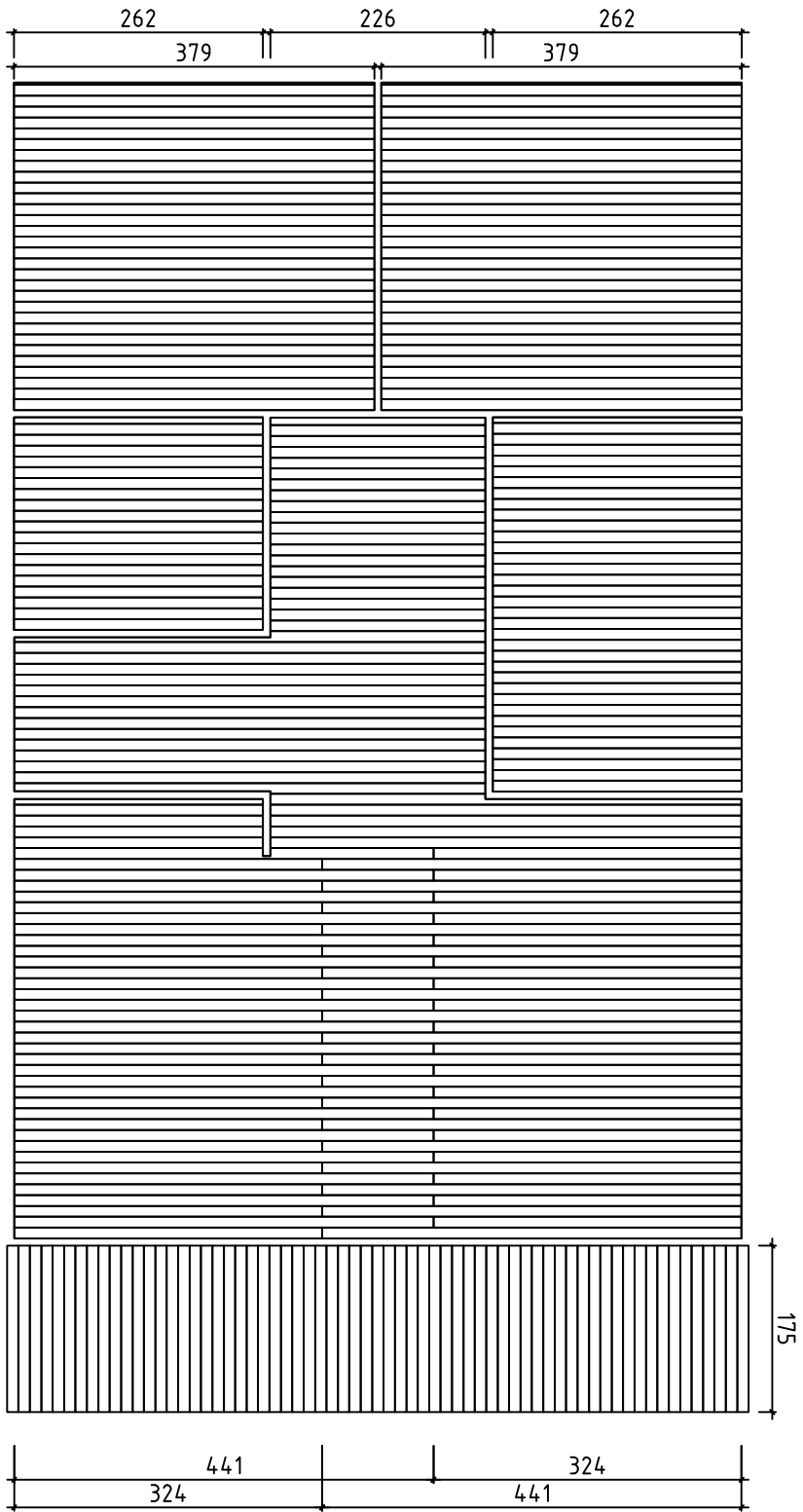

House	Freshford	Sheet	3
Drawing	Plan	Scale	1:75
Material	70x135	Date	07.12.2018
Drawer	K.K.	File	Freshford.dwg

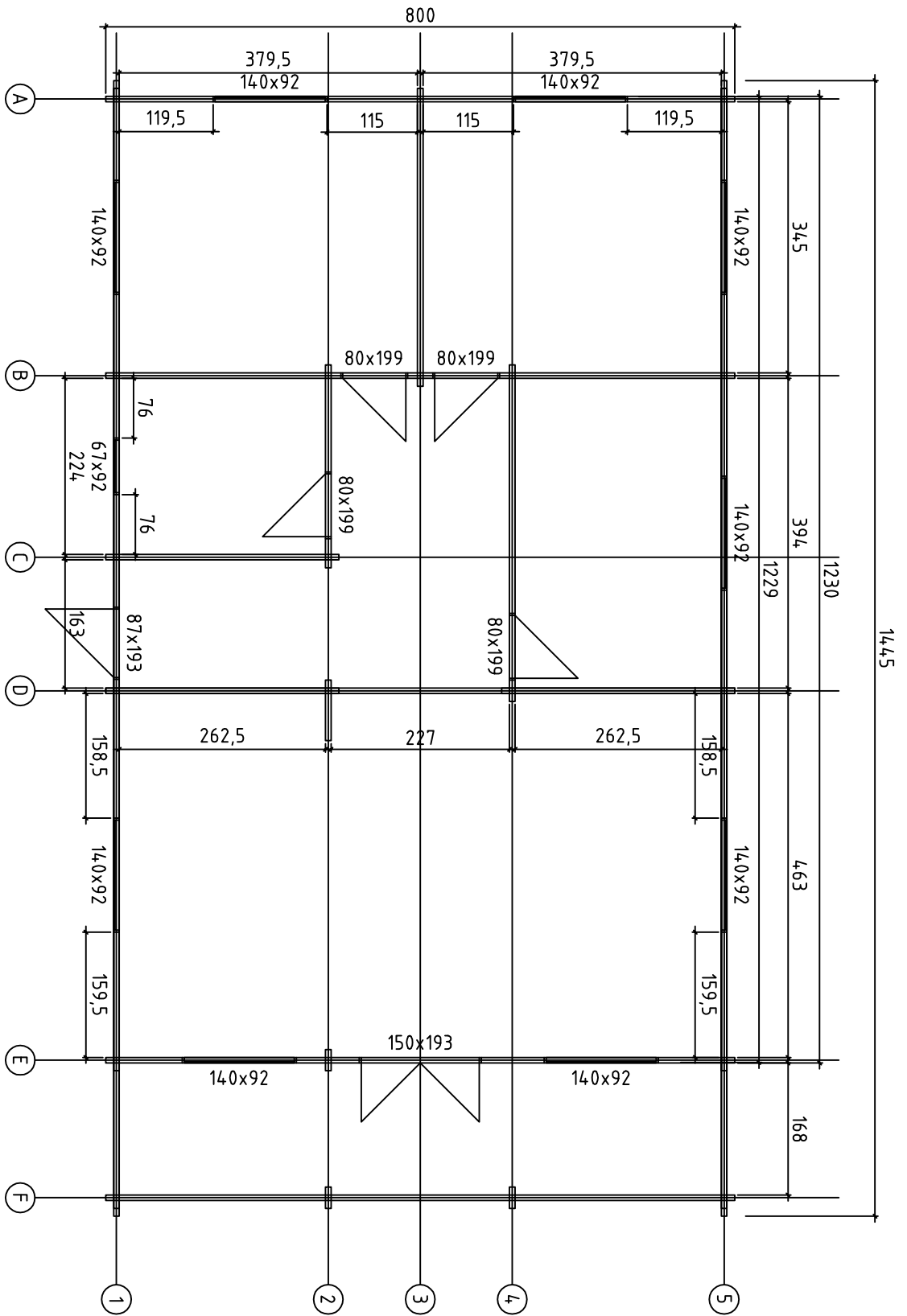

House	Freshford	Sheet	4
Drawing	Plan	Scale	1:75
Material	70x135	Date	07.12.2018
Drawer	K.K.	File	Freshford.dwg

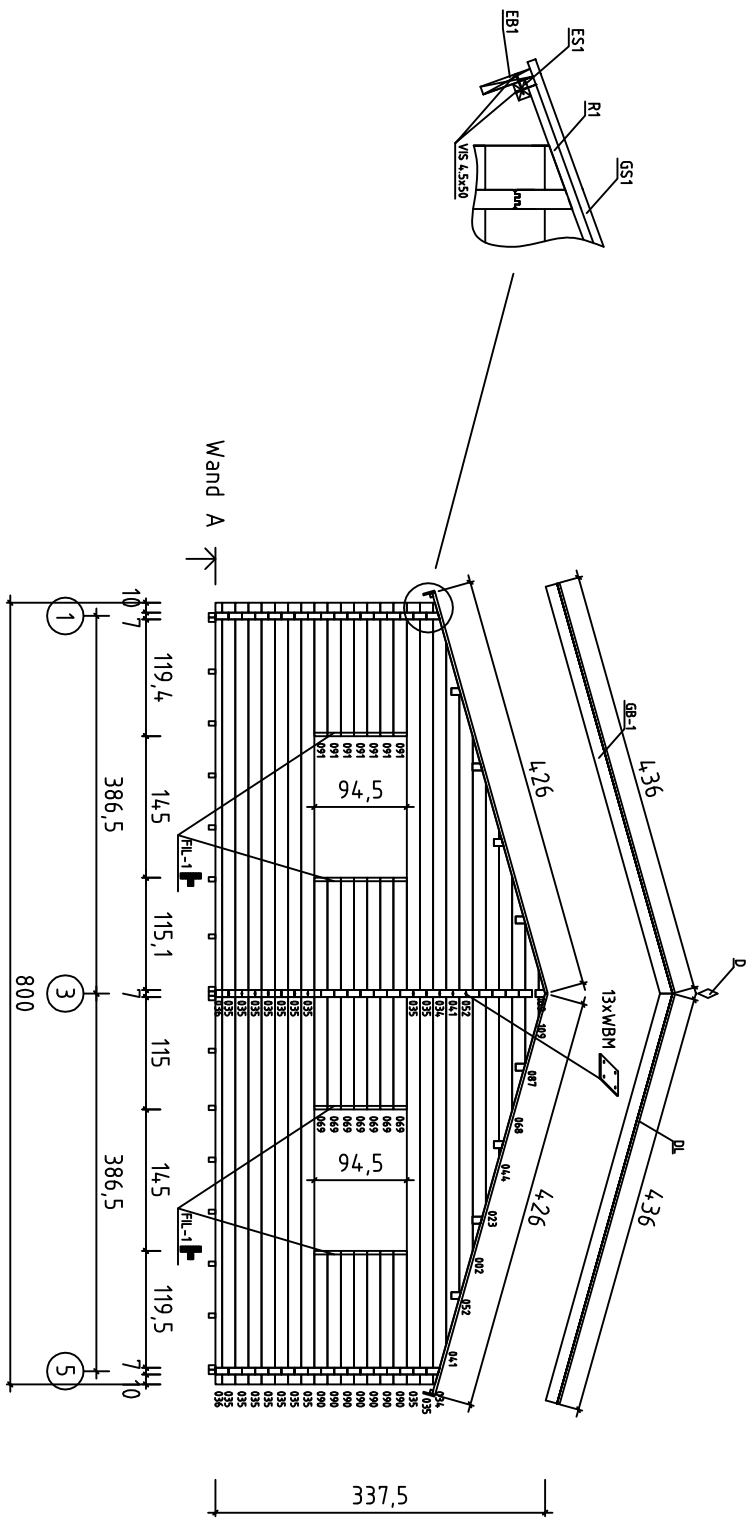

House	Freshford	Sheet	5
Drawing	WAND A	Scale	1:75
Material	7.0x13.5	Date	07.12.2018
Drawer	K.K.	File	Freshford.dwg

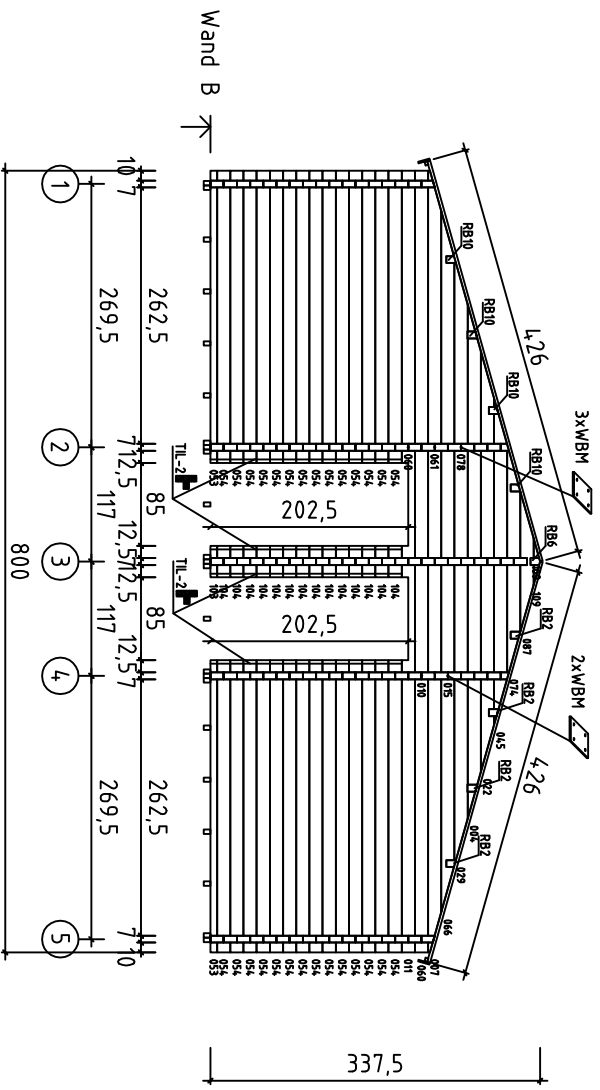

House	Freshford	Sheet	6
Drawing	WAND B	Scale	1:75
Material	7.0x13.5	Date	07.12.2018
Drawer	K.K.	File	Freshford.dwg

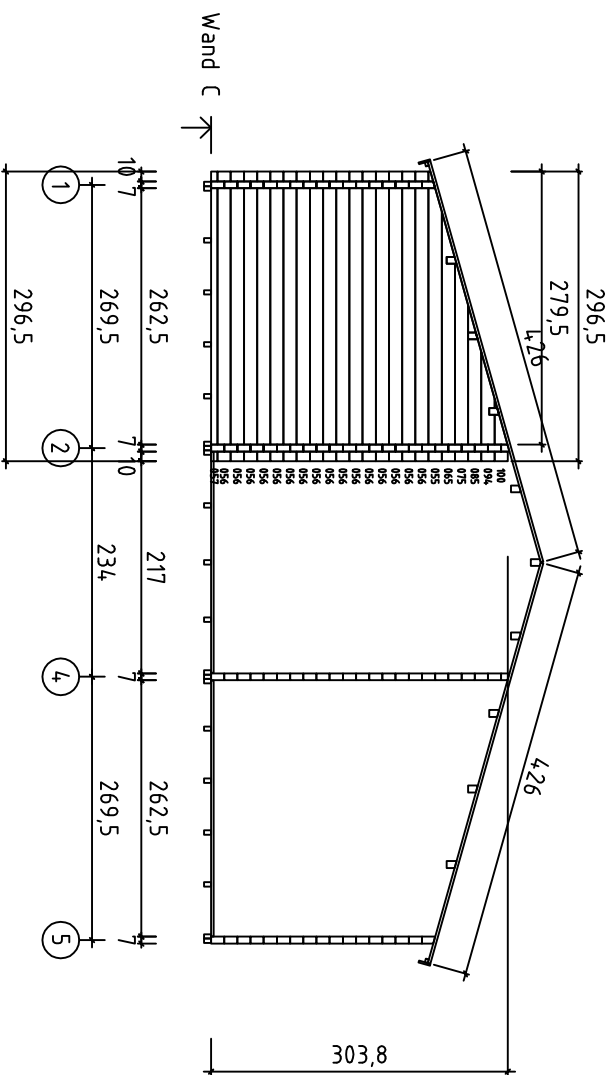

House	Freshford	Sheet	7
Drawing	WAND C	Scale	1:75
Material	7.0x13.5	Date	07.12.2018
Drawer	K.K.	File	Freshford.dwg

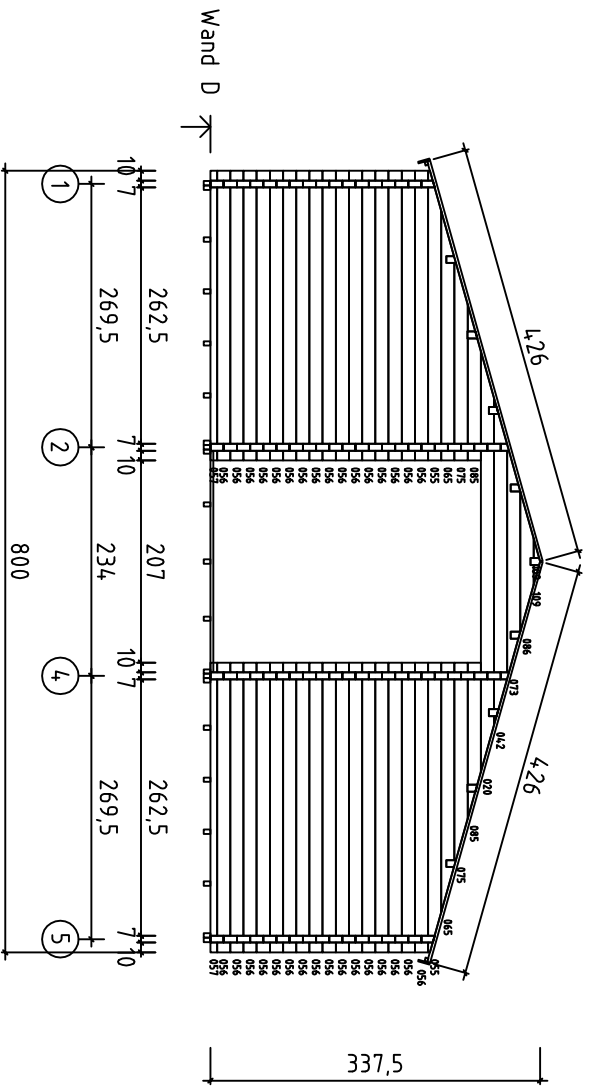

House	Freshford	Sheet	8
Drawing	WAND D	Scale	1:75
Material	7.0x13.5	Date	07.12.2018
Drawer	K.K.	File	Freshford.dwg

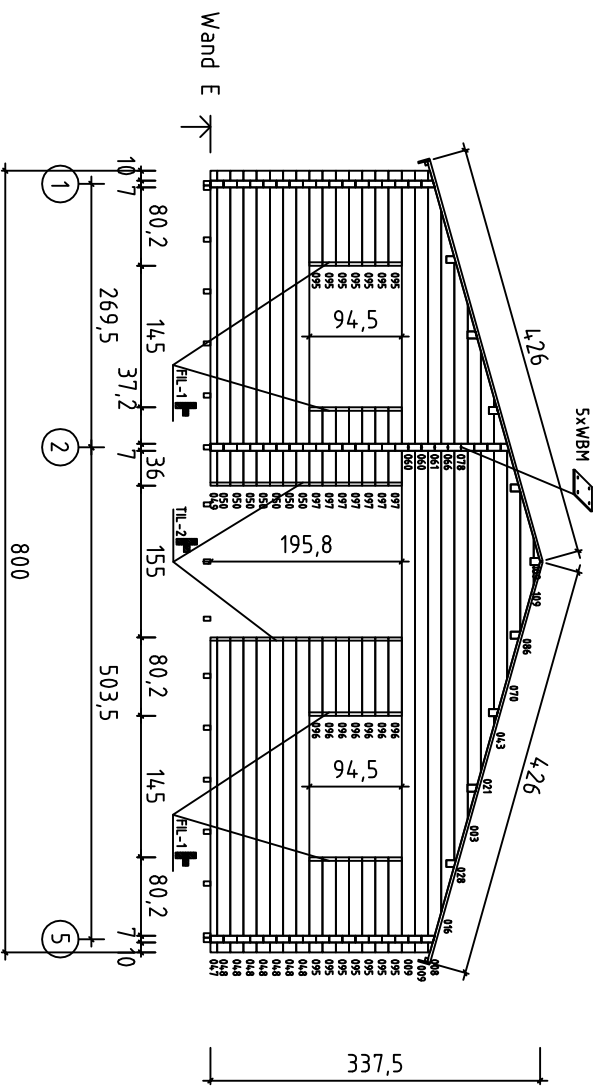

House	Freshford	Sheet	9
Drawing	WAND E	Scale	1:75
Material	7.0x13.5	Date	07.12.2018
Drawer	K.K.	File	Freshford.dwg

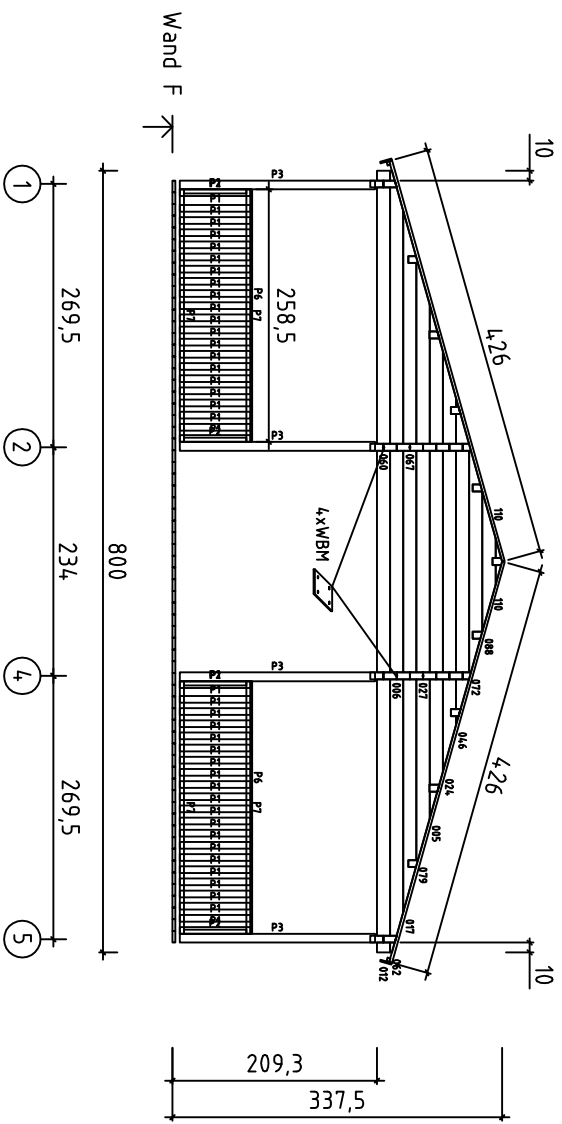

House	Freshford	Sheet	10
Drawing	WAND F	Scale	1:75
Material	7.0x13.5	Date	07.12.2018
Drawer	K.K.	File	Freshford.dwg

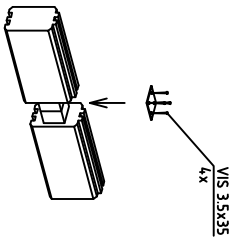
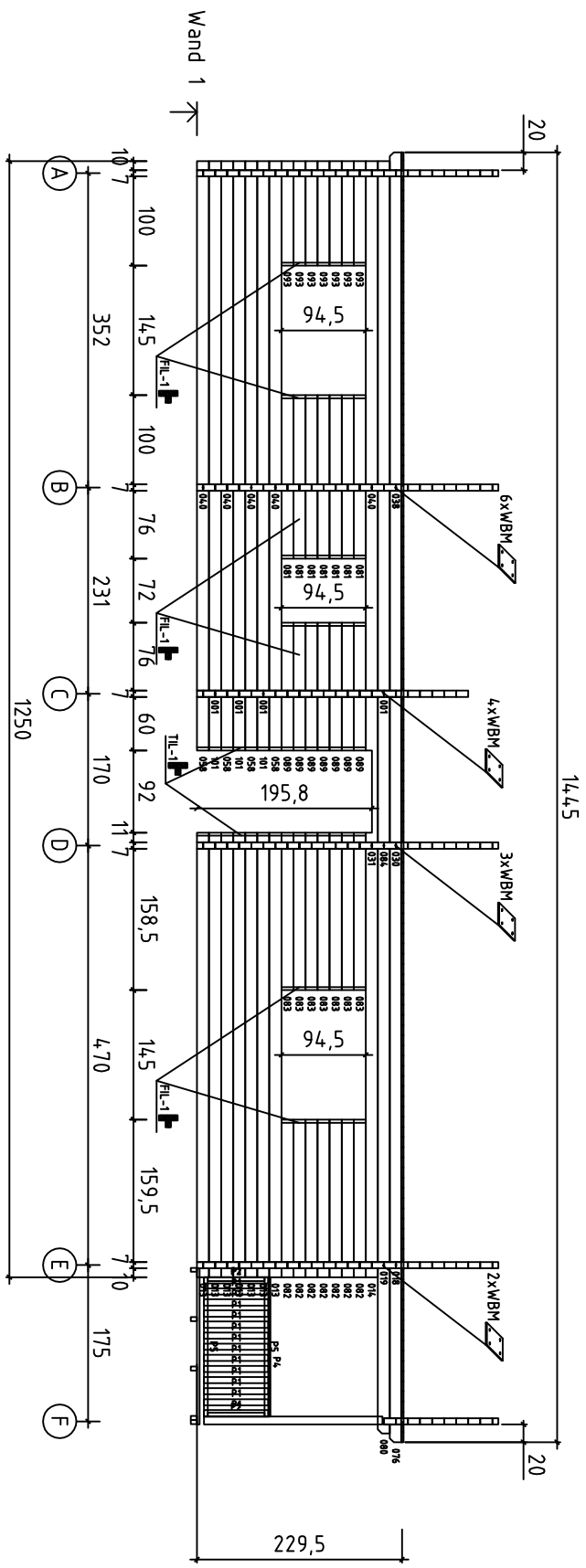

House	Freshford	Sheet	11
Drawing	WAND 1	Scale	1:75
Material	7.0x13.5	Date	07.12.2018
Drawer	K.K.	File	Freshford.dwg

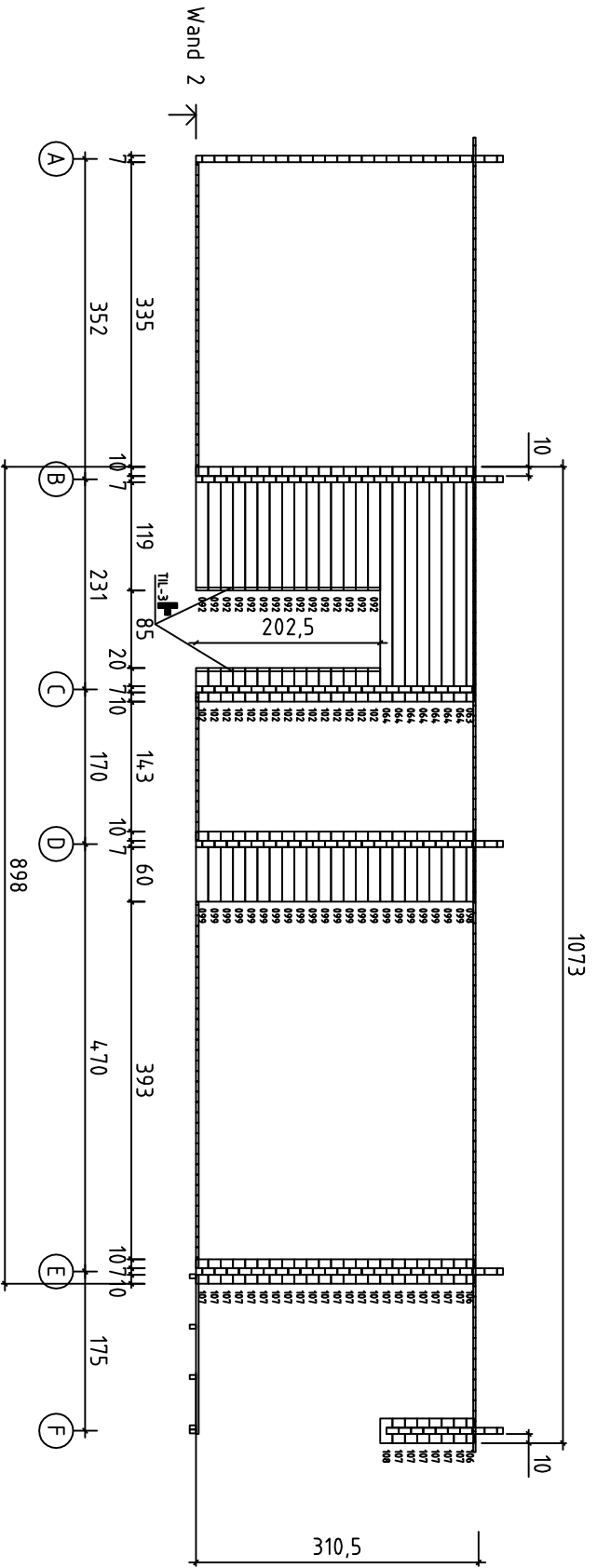

House	Freshford	Sheet	12
Drawing	WAND 2	Scale	1:75
Material	7.0x13.5	Date	07.12.2018
Drawer	K.K.	File	Freshford.dwg

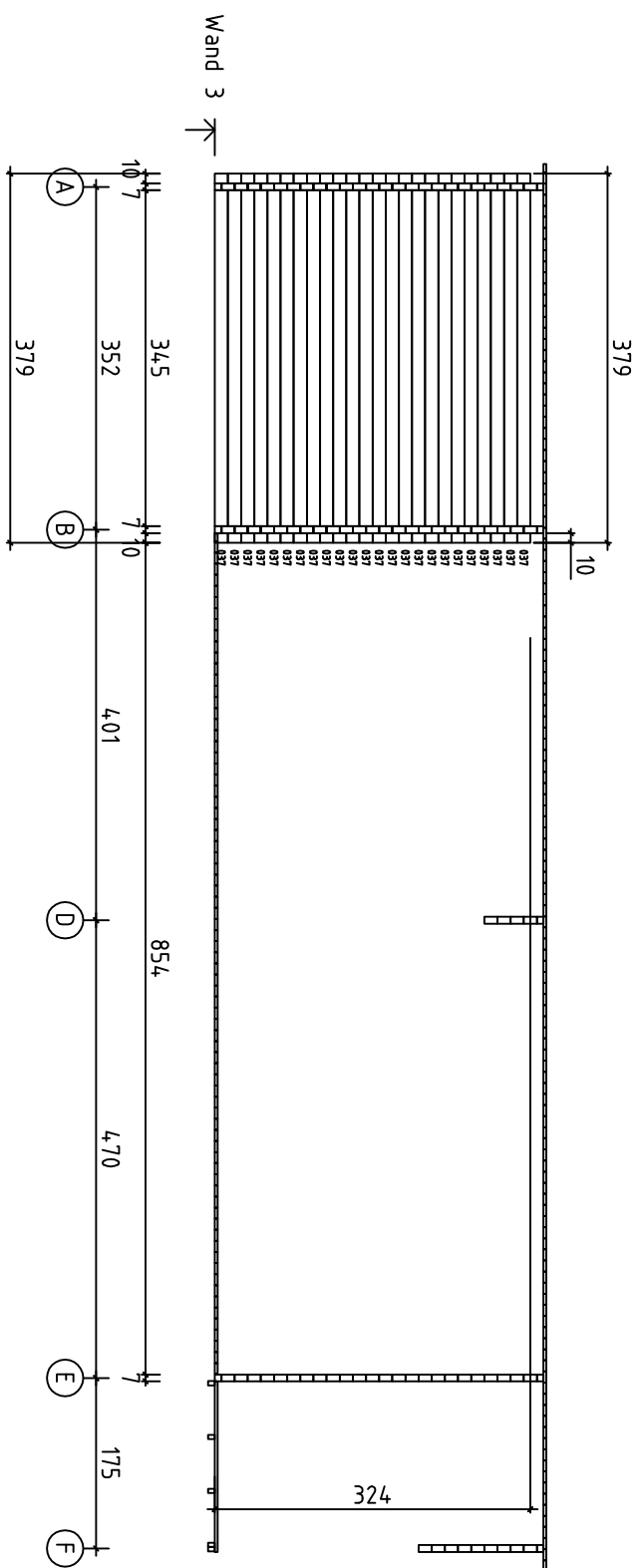

House	Freshford	Sheet	13
Drawing	WAND 3	Scale	1:75
Material	7.0x13.5	Date	07.12.2018
Drawer	K.K.	File	Freshford.dwg

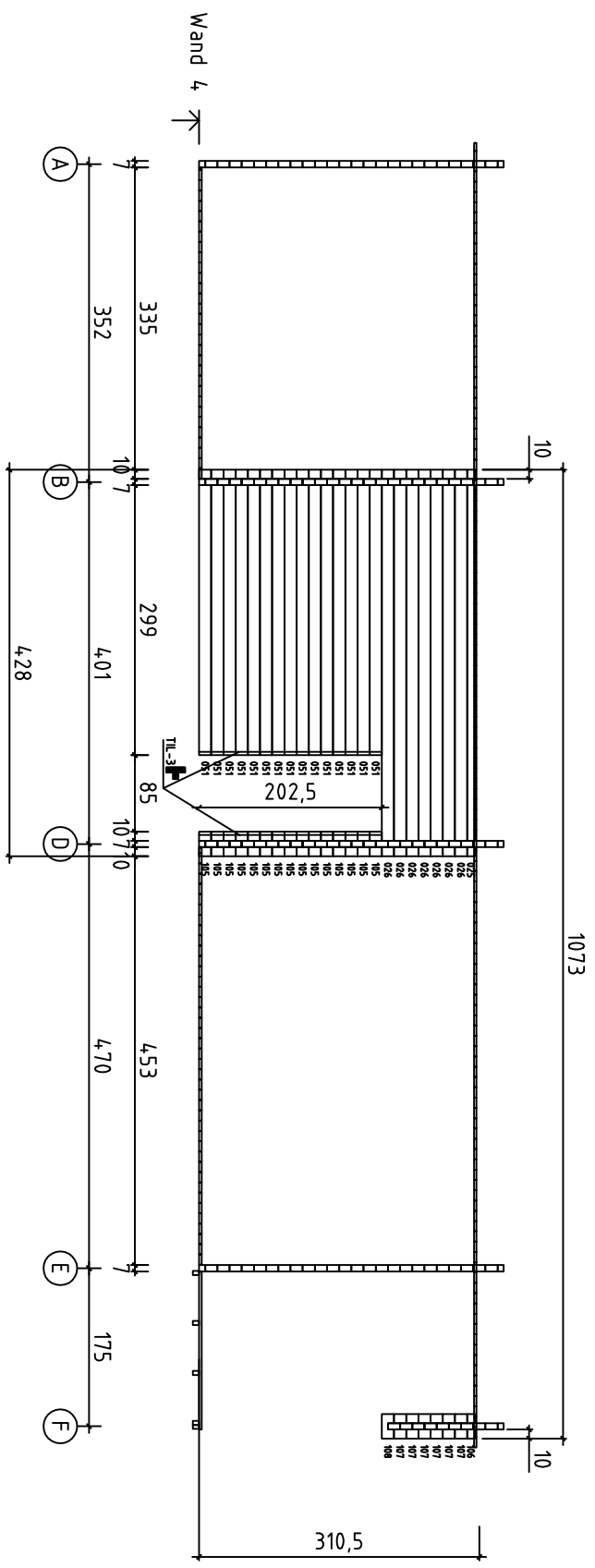



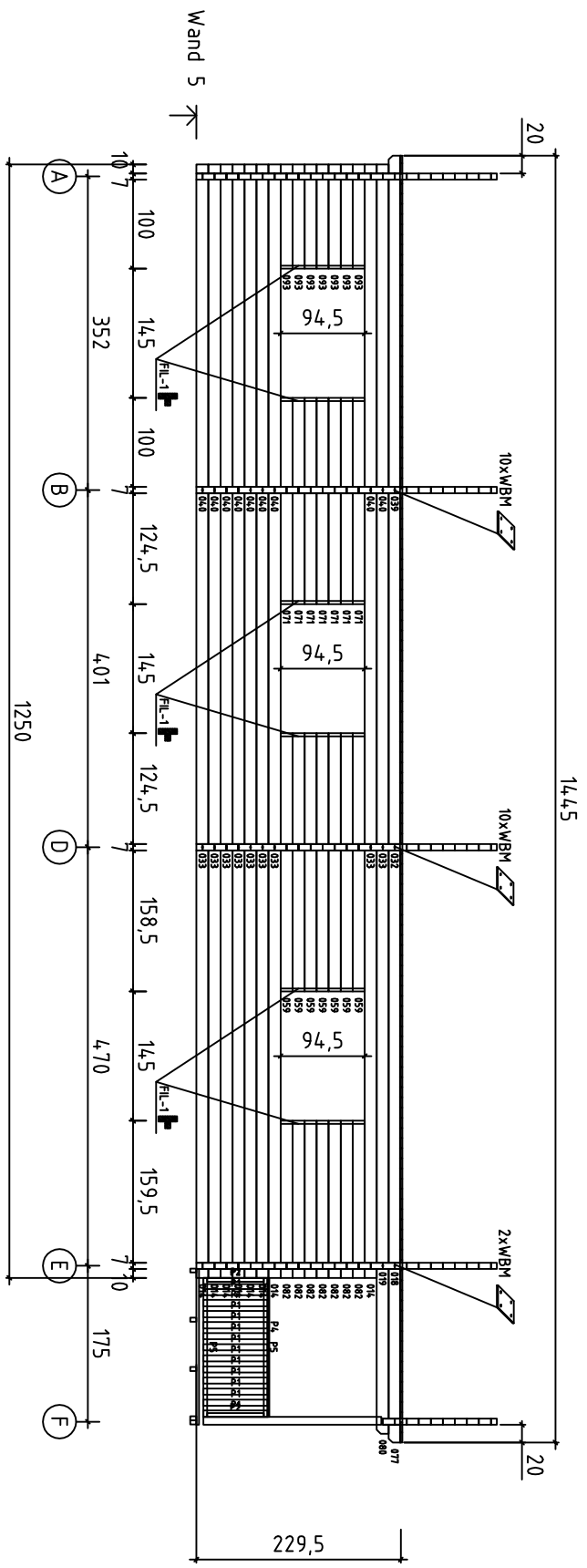

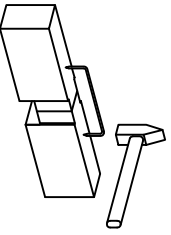
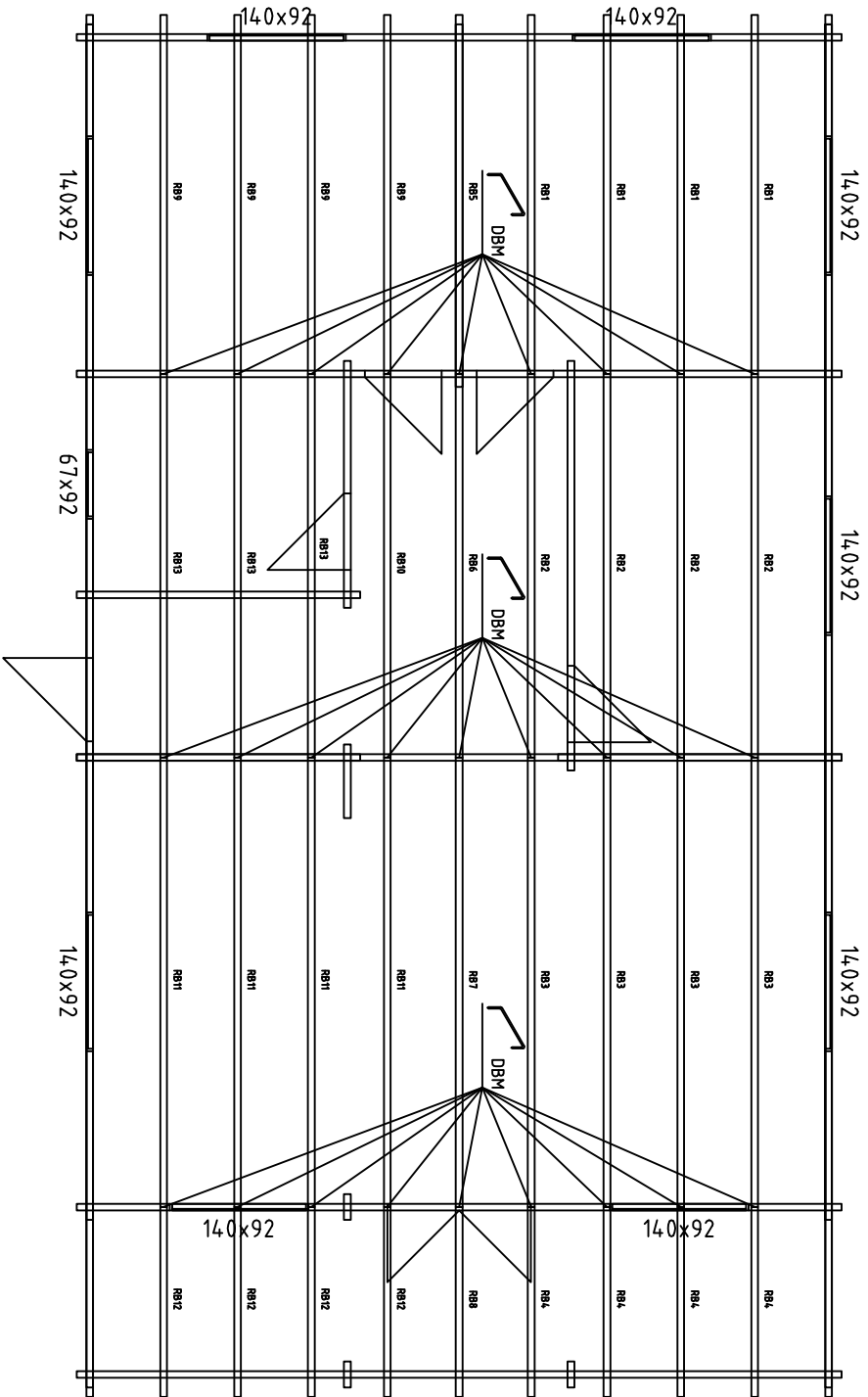

House	Freshford	Sheet	14
Drawing	WAND 4	Scale	1:75
Material	7.0x13.5	Date	07.12.2018
Drawer	K.K.	File	Freshford.dwg



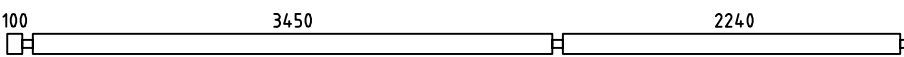
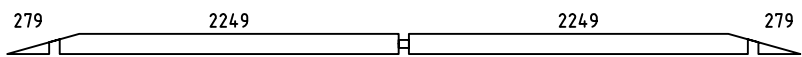
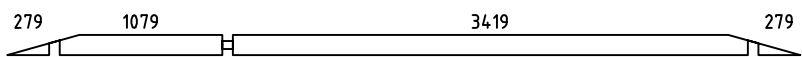
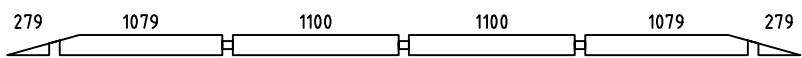
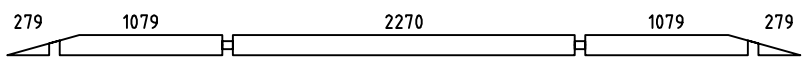
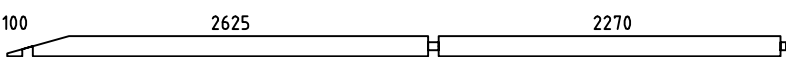
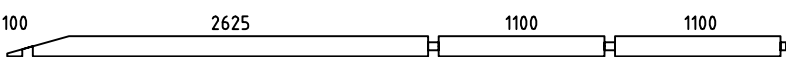
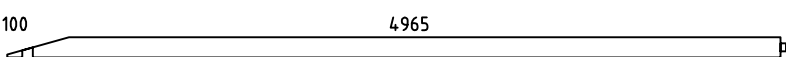
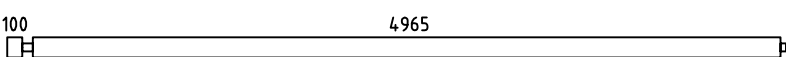
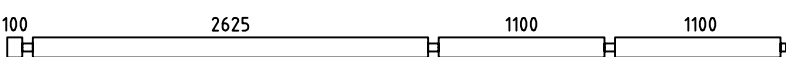
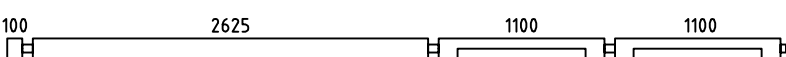
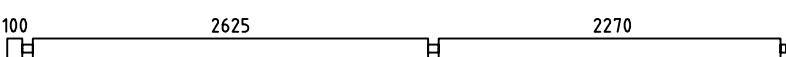
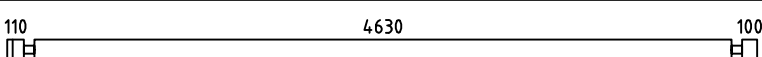
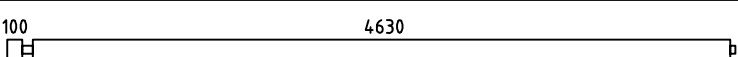

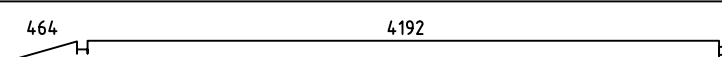

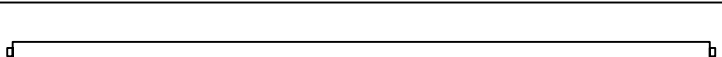
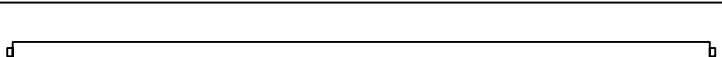
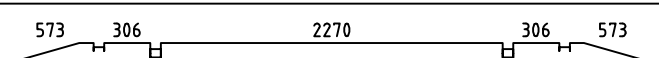
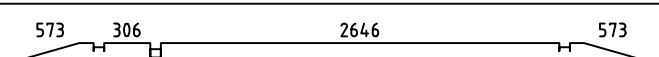

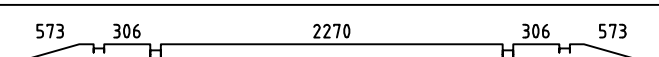
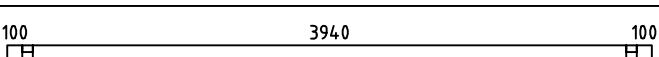
House	Freshford	Sheet	15
Drawing	WAND 5	Scale	1:75
Material	7.0x13.5	Date	07.12.2018
Drawer	K.K.	File	Freshford.dwg

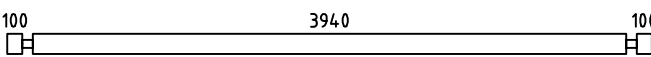
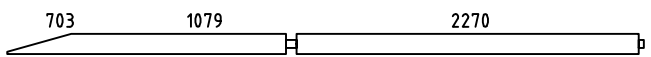
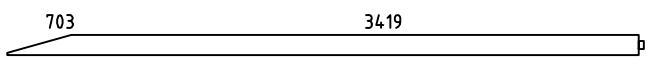
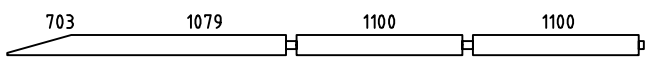
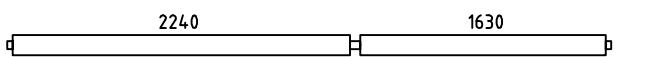

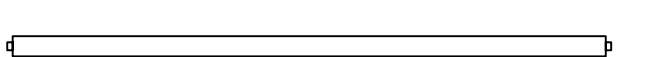
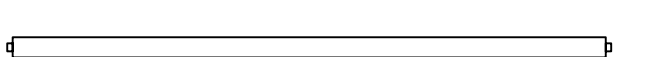
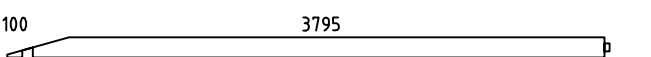
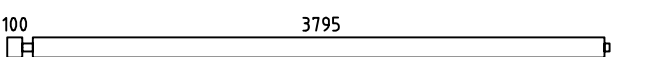
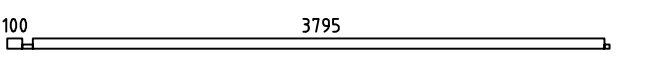
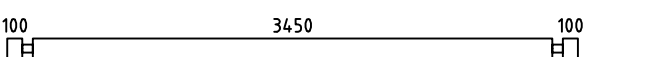
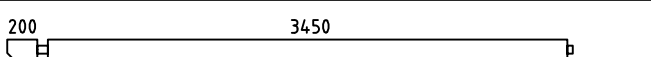
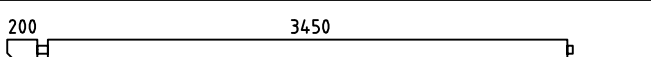
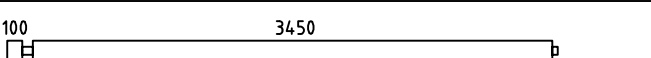
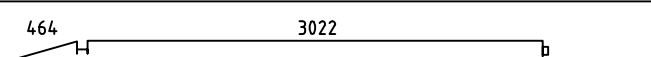
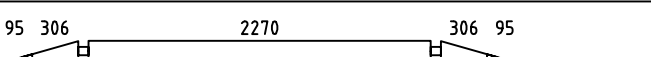
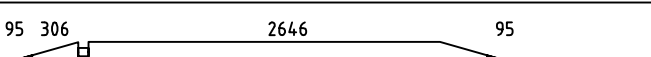
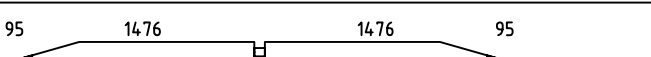
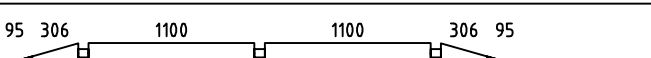
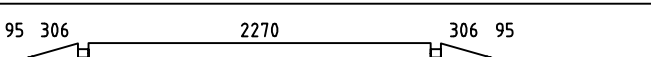
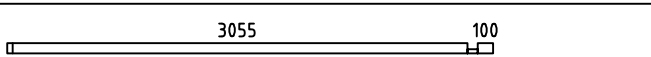
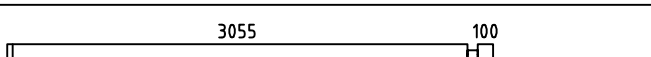
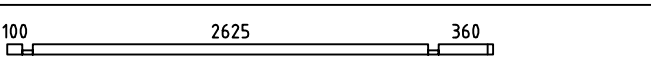
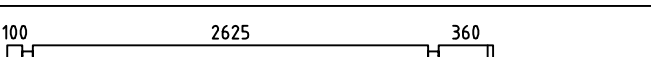

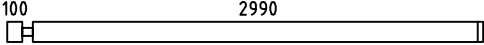
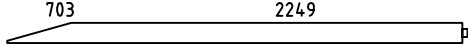
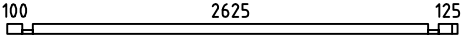
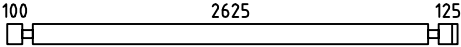
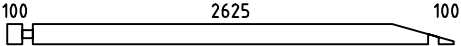
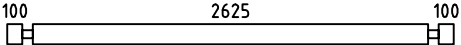
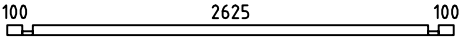
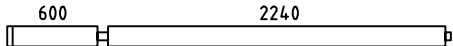

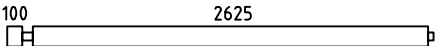
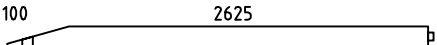
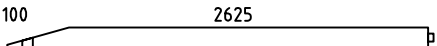
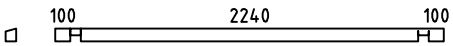
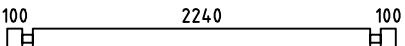
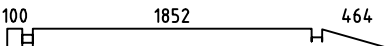
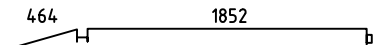
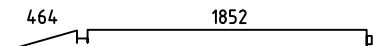

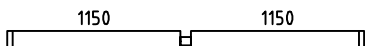
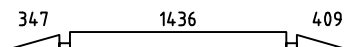
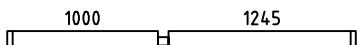
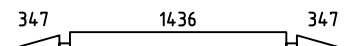
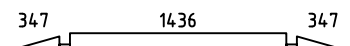
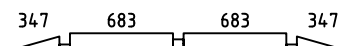
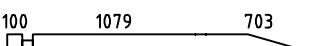

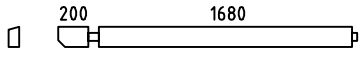
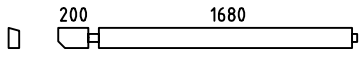
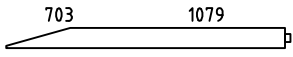
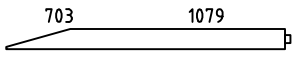
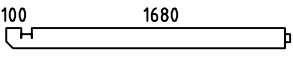
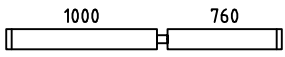
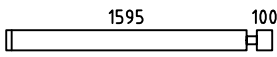
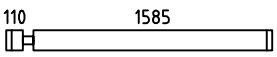
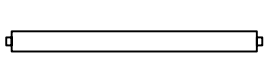
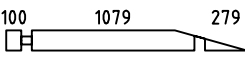
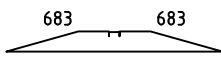
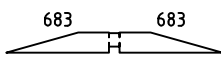
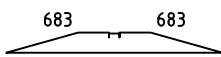
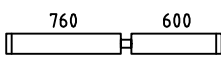
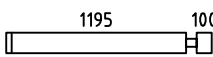
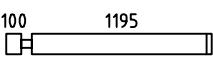
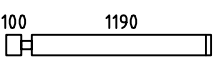
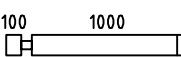
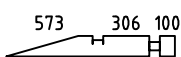
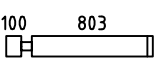
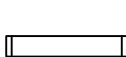
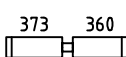
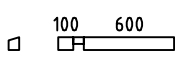
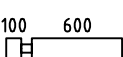



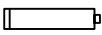

House	Freshford	Sheet	16
Drawing		Scale	1:75
Material	70x140	Date	07.12.2018
Drawer	K.K.	File	Freshford.dwg









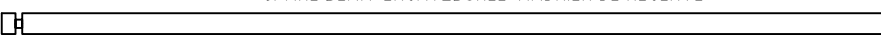
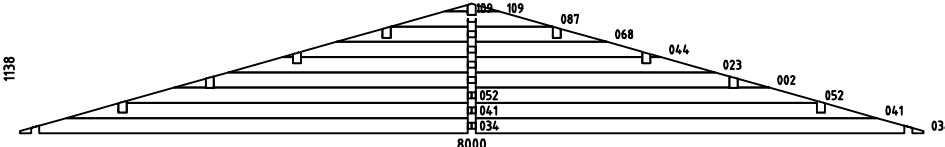
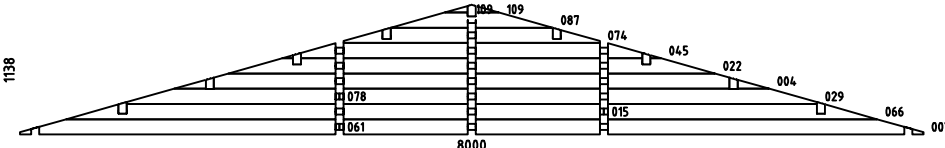
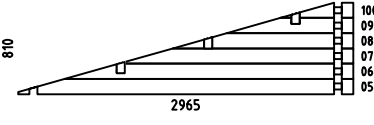
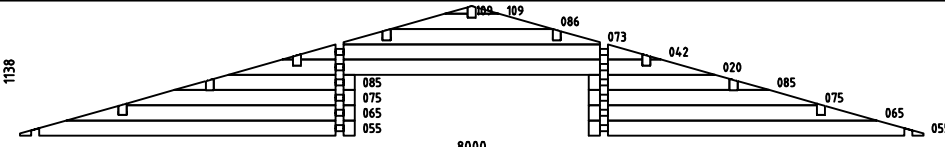
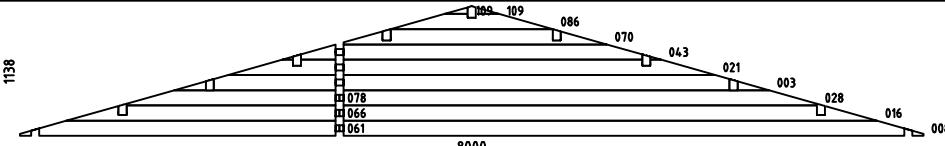
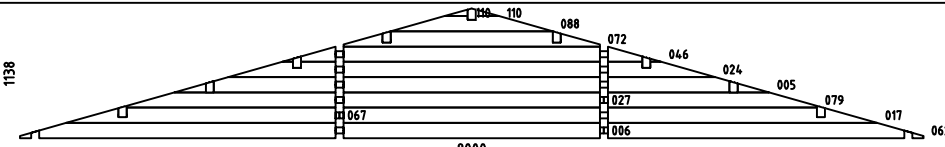
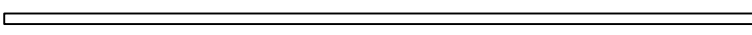

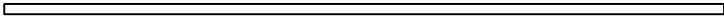
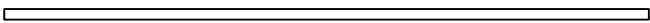
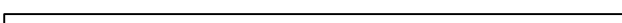
Pos	Freshford	St.	Profil (mm)	L (mm)		
001		4	70x135	5965		
002		1	70x135	5266		
003		1	70x135	5266		
004		1	70x135	5266		
005		1	70x135	5266		
006		1	70x135	5170		
007		1	70x135	5170		
008		1	70x135	5170		
009		2	70x135	5170		
010		1	70x135	5170		
011		1	70x135	5170		
012		1	70x135	5170		
013		7	70x135	4980		
014		9	70x135	4835		
015		1	70x135	4761		
016		1	70x135	4761		
017		1	70x135	4761		
018		2	70x135	4700		
019		2	70x135	4700		
020		1	70x135	4309		
021		1	70x135	4309		
022		1	70x135	4309		
023		1	70x135	4309		
024		1	70x135	4309		
025		1	70x85	4280		
Kood	Freshford	Materjal	File	Freshford.dwg	Leht	17

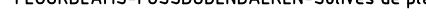

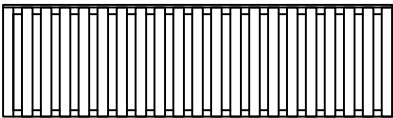
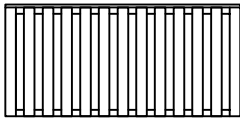
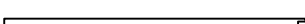
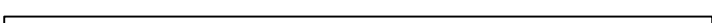
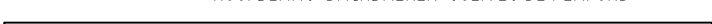
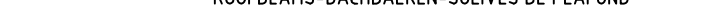
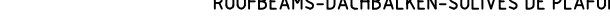



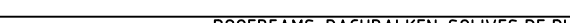
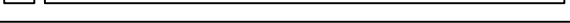
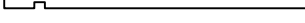

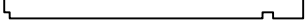















Pos	Freshford	St.	Profil (mm)	L (mm)		
026		7	70x135	4280		
027		1	70x135	4227		
028		1	70x135	4227		
029		1	70x135	4227		
030		1	70x135	4010		
031		1	70x135	4010		
032		1	70x135	4010		
033		9	70x135	4010		
034		2	70x135	4000		
035		18	70x135	4000		
036		2	70x68	4000		
037		24	70x135	3790		
038		1	70x135	3755		
039		1	70x135	3755		
040		14	70x135	3655		
041		2	70x135	3591		
042		1	70x135	3351		
043		1	70x135	3351		
044		1	70x135	3351		
045		1	70x135	3351		
046		1	70x135	3351		
047		1	70x68	3225		
048		7	70x135	3225		
049		1	70x68	3225		
050		7	70x135	3225		
Kood	Freshford	Materjal	File	Freshford.dwg	Leht	18









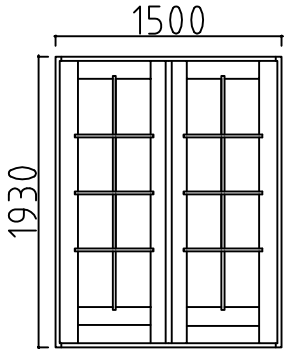
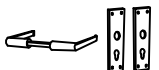

Pos	Freshford	St.	Profil (mm)	L (mm)		
051		15	70x135	3160		
052		2	70x135	3057		
053		2	70x68	2990		
054		28	70x135	2990		
055		3	70x135	2965		
056		48	70x135	2965		
057		3	70x68	2965		
058		4	70x135	2945		
059		7	70x135	2900		
060		5	70x135	2830		
061		2	70x135	2830		
062		1	70x135	2830		
063		1	70x85	2580		
064		7	70x135	2580		
065		3	70x135	2556		
066		2	70x135	2421		
067		1	70x135	2421		
068		1	70x135	2394		
069		7	70x135	2370		
070		1	70x135	2332		
071		7	70x135	2315		
072		1	70x135	2270		
073		1	70x135	2270		
074		1	70x135	2270		
075		3	70x135	2022		
Kood	Freshford	Materjal	File	Freshford.dwg	Leht	19

Pos	Freshford	St.	Profil (mm)	L (mm)		
076		1	70x135	1985		
077		1	70x135	1985		
078		2	70x135	1887		
079		1	70x135	1887		
080		2	70x135	1885		
081		7	70x135	1830		
082		14	70x135	1765		
083		7	70x135	1765		
084		1	70x135	1700		
085		3	70x135	1598		
086		2	70x135	1436		
087		2	70x135	1436		
088		1	70x135	1436		
089		7	70x135	1430		
090		7	70x135	1365		
091		7	70x135	1365		
092		15	70x135	1360		
093		14	70x135	1170		
094		1	70x135	1119		
095		14	70x135	973		
096		7	70x135	803		
097		7	70x135	803		
098		1	70x85	770		
099		22	70x135	770		
100		1	70x135	641		
Kood	Freshford	Materjal	File	Freshford.dwg	Leht	20

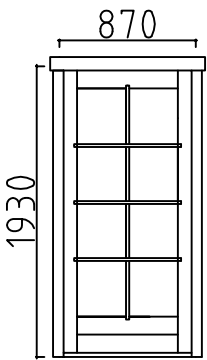
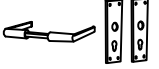
Pos	Freshford	St.	Profil (mm)	L (mm)		
101		3	70x135	635		
102	200 100 	15	70x135	370		
103	125 125 	1	70x68	320		
104	125 125 	14	70x135	320		
105	100100 	15	70x135	270		
106	 100100 	3	70x85	270		
107	100100 	34	70x135	270		
108	100100 	2	70x135	270		
109		8	70x58	204		
110		2	70x58	204		
SH	HIT BLOCK-SCHLAGHÖLZER-MADRIERS D'ASSEMBLAGE 	2	70x135	300		
SB	SPARE BEAM-ERSATZBOHLE-MADRIER DE RESERVE 	1	70x135	5965		
WA-1		1	70x1138	8000		
WB-1		1	70x1138	8000		
WC-1		1	70x810	2965		
WD-1		1	70x1138	8000		
WE-1		1	70x1138	8000		
WF-1		1	70x1138	8000		
FBI2	FLOORBEAMS-FUSSBODENBALKEN-Solives de plancher (IMPREGNATED-IMPREGNIERT-imprégnés)  IMM	5	45x70	5000		
Kood	Freshford	Materjal	File	Freshford.dwg	Leht	21

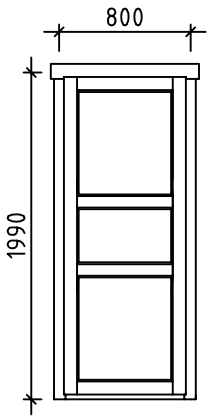
Pos	Freshford	St.	Profil (mm)	L (mm)		
FBI8	FLOORBEAMS-FUSSBODENBALKEN-Solives de plancher (IMPREGNATED-IMPREGNIERT-imprégnés)  IMM	2	45x70	4780		
FBI6	FLOORBEAMS-FUSSBODENBALKEN-Solives de plancher (IMPREGNATED-IMPREGNIERT-imprégnés)  IMM	2	45x70	4280		
FBI5	FLOORBEAMS-FUSSBODENBALKEN-Solives de plancher (IMPREGNATED-IMPREGNIERT-imprégnés)  IMM	17	45x70	4110		
FBI4	FLOORBEAMS-FUSSBODENBALKEN-Solives de plancher (IMPREGNATED-IMPREGNIERT-imprégnés)  IMM	34	45x70	4090		
FBI7	FLOORBEAMS-FUSSBODENBALKEN-Solives de plancher (IMPREGNATED-IMPREGNIERT-imprégnés)  IMM	2	45x70	3685		
FBI3	FLOORBEAMS-FUSSBODENBALKEN-Solives de plancher (IMPREGNATED-IMPREGNIERT-imprégnés)  IMM	5	45x70	2790		
FBI1	FLOORBEAMS-FUSSBODENBALKEN-Solives de plancher (IMPREGNATED-IMPREGNIERT-imprégnés)  IMM	4	45x70	495		
B1	BALCONY BANISTER-PARVEKKEEN KAIDE -BALKONGRÄCKE 	2	61x742	2585		
B2	BALCONY BANISTER-PARVEKKEEN KAIDE -BALKONGRÄCKE 	2	61x742	1560		
P3	POST-PFOSTEN-POTEAU 	4	90x90	2000		
RB3	ROOFBEAMS-DACHBALKEN-SOLIVES DE PLAFOND 	4	70x140	4700		
RB11	ROOFBEAMS-DACHBALKEN-SOLIVES DE PLAFOND 	4	70x140	4700		
RB7	ROOFBEAMS-DACHBALKEN-SOLIVES DE PLAFOND 	1	70x140	4700		
RB2	ROOFBEAMS-DACHBALKEN-SOLIVES DE PLAFOND 	4	70x140	4010		
RB10	ROOFBEAMS-DACHBALKEN-SOLIVES DE PLAFOND 	1	70x140	4010		
RB13	ROOFBEAMS-DACHBALKEN-SOLIVES DE PLAFOND 2240  1630	3	70x140	4010		
RB6	ROOFBEAMS-DACHBALKEN-SOLIVES DE PLAFOND 	1	70x140	4010		
RB1	ROOFBEAMS-DACHBALKEN-SOLIVES DE PLAFOND 200  3450	4	70x140	3755		
RB9	ROOFBEAMS-DACHBALKEN-SOLIVES DE PLAFOND 200  3450	4	70x140	3755		
RB5	ROOFBEAMS-DACHBALKEN-SOLIVES DE PLAFOND 200  3450	1	70x140	3755		
RB4	ROOFBEAMS-DACHBALKEN-SOLIVES DE PLAFOND 1680  200	4	70x140	1985		
RB12	ROOFBEAMS-DACHBALKEN-SOLIVES DE PLAFOND 1680  200	4	70x140	1985		
RB8	ROOFBEAMS-DACHBALKEN-SOLIVES DE PLAFOND 1680  200	1	70x140	1985		
Kood	Freshford	Materjal	File	Freshford.dwg	Leht	22

	Freshford		St.	Profil (mm)	L (mm)
	FLOORBOARDS-FUSSBODENBRETTER-PLANCHER	 88mm or-oder-ou 114mm	26+1 20+1	28x88 28x114	4955
	FLOORBOARDS-FUSSBODENBRETTER-PLANCHER	 88mm or-oder-ou 114mm	47+1 36+1	28x88 28x114	4410
	FLOORBOARDS-FUSSBODENBRETTER-PLANCHER	 88mm or-oder-ou 114mm	81 62	28x88 28x114	3790
	FLOORBOARDS-FUSSBODENBRETTER-PLANCHER	 88mm or-oder-ou 114mm	47 36	28x88 28x114	3240
	FLOORBOARDS-FUSSBODENBRETTER-PLANCHER	 88mm or-oder-ou 114mm	78 60	28x88 28x114	2620
	FLOORBOARDS-FUSSBODENBRETTER-PLANCHER	 88mm or-oder-ou 114mm	26 20	28x88 28x114	2260
	TERRACE BORDERS-TERRASSEN BEGRÄNZUNG-Plancher de terrasse (IMPREGNATED-IMPREGNIERT-imprégnés)	 IMM	65+1	120x28	1750
R	ROOFBOARD/DACHBRETTER/KATTOLAUTA	 88mm or-oder-ou 114mm	330+1 254+1	28x88 28x114	4260
SL	SKIRTING SLAT-FUSSBODENLEISTE-BAGUETTE			18x35	91.0
GB-1	GABLE BOARD-GIEBELBLENDE-PLANCHE DE RIVE		4	19x120	4360
EB-1	EAVE BOARD-TRAUFBRETT-LATTES SOUS VOLIGES		6	19x120	4817
ES	EAVE SLAT-TRAUFENLEISTE- Baguettes pour fixer les lattes sous voliges		6	30x40	4817
RFF	ROOF FELT FILLET-GIEBELLEISTE- Baguettes pour fixer les planches de rive		4	18x70	4360
D	DIAMOND-RAUTE-ELEMENT DE DECORATION		2	18x90	200
TIL-1 TIL-2	DOOR ASSEMBLING PROFILE-TÜR INSTALLIERUNGSPROFIL -Tasseau de fixation pour portes		2 6	43x70	1870 1930
TIL-3	DOOR ASSEMBLING PROFILE-TÜR INSTALLIERUNGSPROFIL -Tasseau de fixation pour portes		4	43x70	1990
FIL-1	WINDOW ASSEMBLING PROFILE-FENSTER INSTALLIERUNGSPROFIL -Tasseau de fixation pour fenêtres		20	43x70	920
	REGULATING BOLT-REGULIERUNGSBOLZEN-Elément de fixation pour poteau		4		
DBM	ROOFBEAMS CONNECTING METAL-DACHBALKEN BEFESTIGUNGSMETALLE- Connecteur métallique pour solives de plafond		27		
WBM	WALL FIXING PLATE-WANDBOHLLEN BEFESTIGUNGSMETALLE- PATTE D'ASSEMBLAGE		64	50	50
	STEEL CORNER-METALLVINKEL-Equerre de renfort	 FOR FLOORBEAMS FÜR FUSSBODENBALKEN Solives de plancher	23	40x40	
	SCREW-SCHRAUBEN-VIS	 DECORATIV, ROOF FELT FILLET LISTOILLE, KULMARAUDOILLE STEEL CORNER, SKIRTING SLAT	140	3,5x35	
SC1	CONNECTEUR MÉTALLIQUE POUR FRONTIÈRES TERRASSE		4	40x30	90
	SCREWS-SCHRAUBEN-SCHROEF	SC1 	4	ø6	50
	WASHER-SCHEIBE-SCHIJF	SC1 	4	ø6	
Kood	Freshford	Materjal	File	Freshford.dwg	Leht 23

Freshford		St.	Profil (mm)	L (mm)		
Doubledoor-Doppeltür-Double porte 1500x1930 - 1 pcs-st-unt (r-r-d) ISO						
	ORT_1H	P.P.	1	1500	1930	
			1			
			1			
			2			
			1			
Door-Tür-Porte 870x1930 - 1 pcs-st-unt (1 left-links-Gauche) ISO						
	ORT_1H	V. 1tk.	1	870	1930	
			1			
			1			
			1			
	Door-Tür-Porte 800x1990 (2 right-rechts-Droit) (2 left-links-Gauche)					
	Ast_SU	2V.P. 2P.P.	4	800	1990	
			4			
			4			
			4			
	Kood	Freshford	Materjal	File	Freshford.dwg	Leht

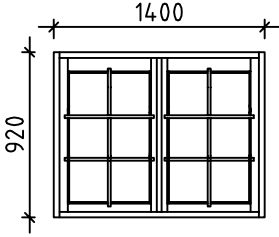
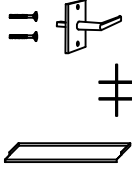
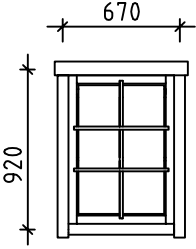
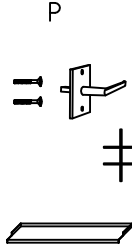
Freshford		St.	Profil (mm)	L (mm)
WINDOW-FENSTER-Fenêtre 1400x920 - 9 pcs-st-unt ISO				
	ORT_1H		9 9 18 9	1400 920
WINDOW-FENSTER-Fenêtre 670x920 1 pcs-st-unt (right-rechts-Droit)				
	ORT_1H		1 1 1 1	670 920
Kood	Freshford	Materjal	File	Freshford.dwg
			Leht	25